



SOME MILESTONES IN HISTORY OF CONCRETE

First and oldest examples in the last 2 centuries

Yasin Engin (Civil Eng., MSc)
yasin.engin@gmail.com
www.betonvecimento.com

May, 2015

First

PLAIN CONCRETE HOUSE

Oldest



Year: 1835

Place: Kent, UK

Designer: John Bazley White

First

REINFORCED CONCRETE STRUCTURE

Oldest

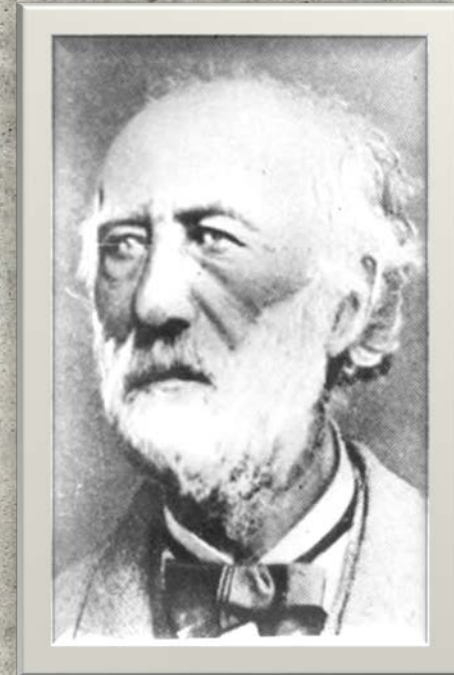

Year: 1848

Place: France

Inventor: Joseph-Louis Lambot

First

CONCRETE+STEEL BUILDING

Oldest



Year: 1853

Place: Paris, France

Builder: François Coignet

First

REINFORCED CONCRETE BRIDGE

Oldest

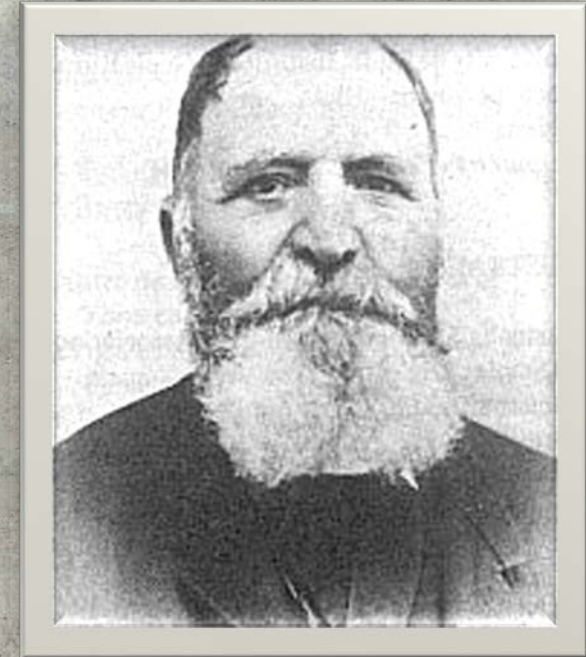

Year: 1875

Place: France

Inventor: Joseph Monier

First

PLAIN CONCRETE DAM

Oldest

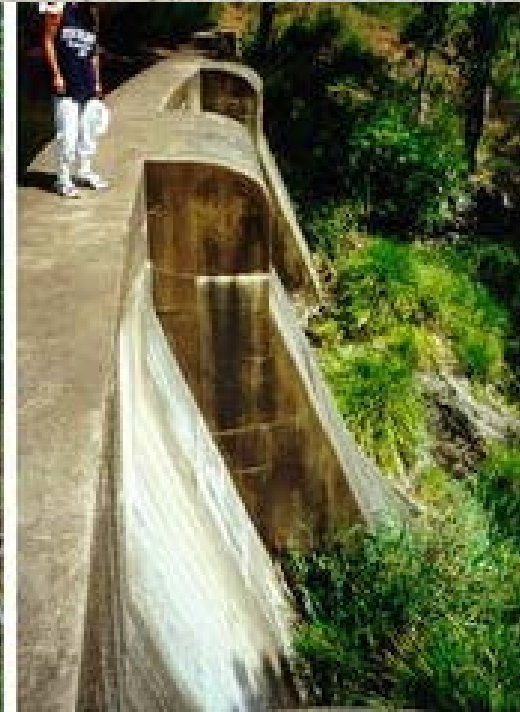

The 75 Miles Dam

Year: 1880

Place: Warwick, Australia

First

PLAIN CONCRETE BRIDGE

Oldest



L'AN 1812
A ETE COMMENCEE LA CONSTRUCTION
DE CE PONT SOUS LA DIRECTION
DE
LOUIS VICAT
INGENIEUR DES PONTS & CHAUSSEES
QUI A LE PREMIER ETABLI LA THEORIE
ET MIS AU POINT LA FABRICATION DES
CHAUX HYDRAULIQUES ARTIFICIELLES

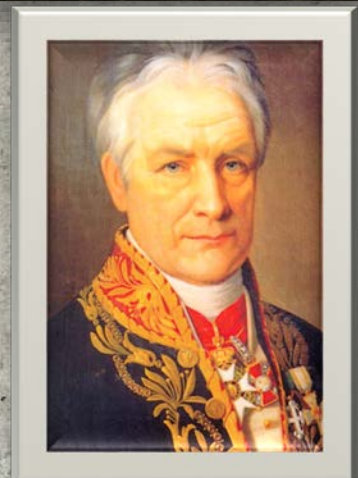

Year: 1816

Place: Souillac, France

Builder: Louis Joseph Vicat

First

CONCRETE ROAD

Oldest

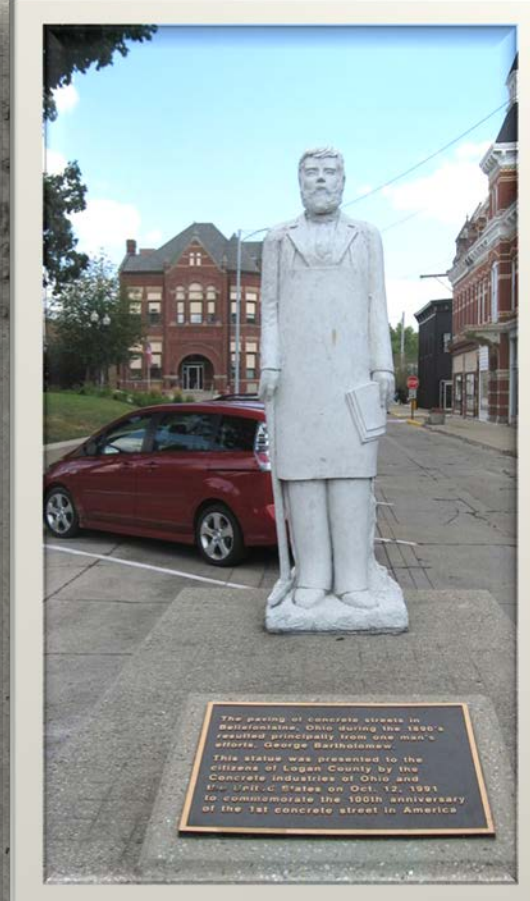

Year: 1861

Place: Ohio, USA

Inventor: George Bartholomew

First

REINFORCED CONCRETE BUILDING

Oldest

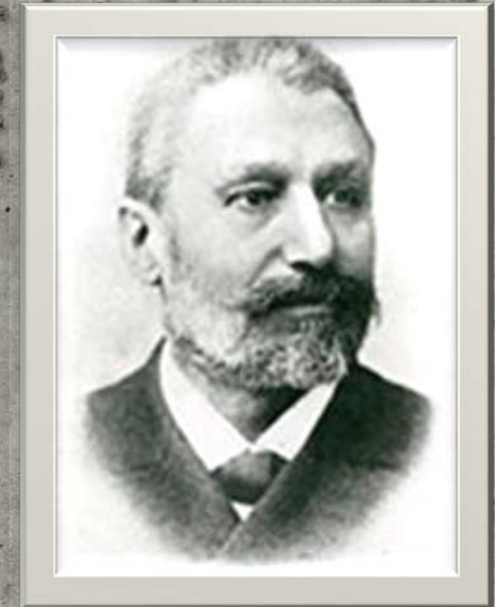

Year: 1892

Place: Paris, France

Builder: Francois Hennebique

First

CONCRETE PILE

Oldest

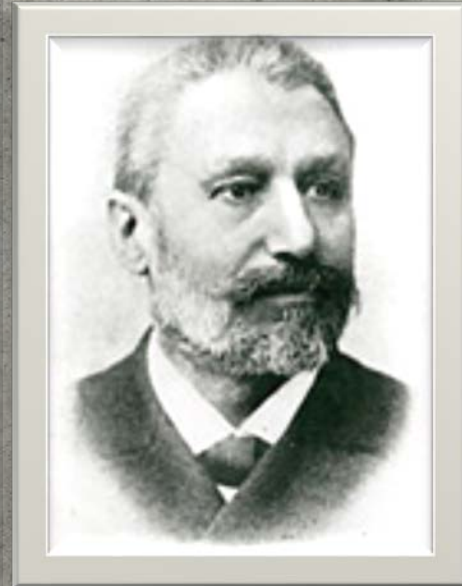
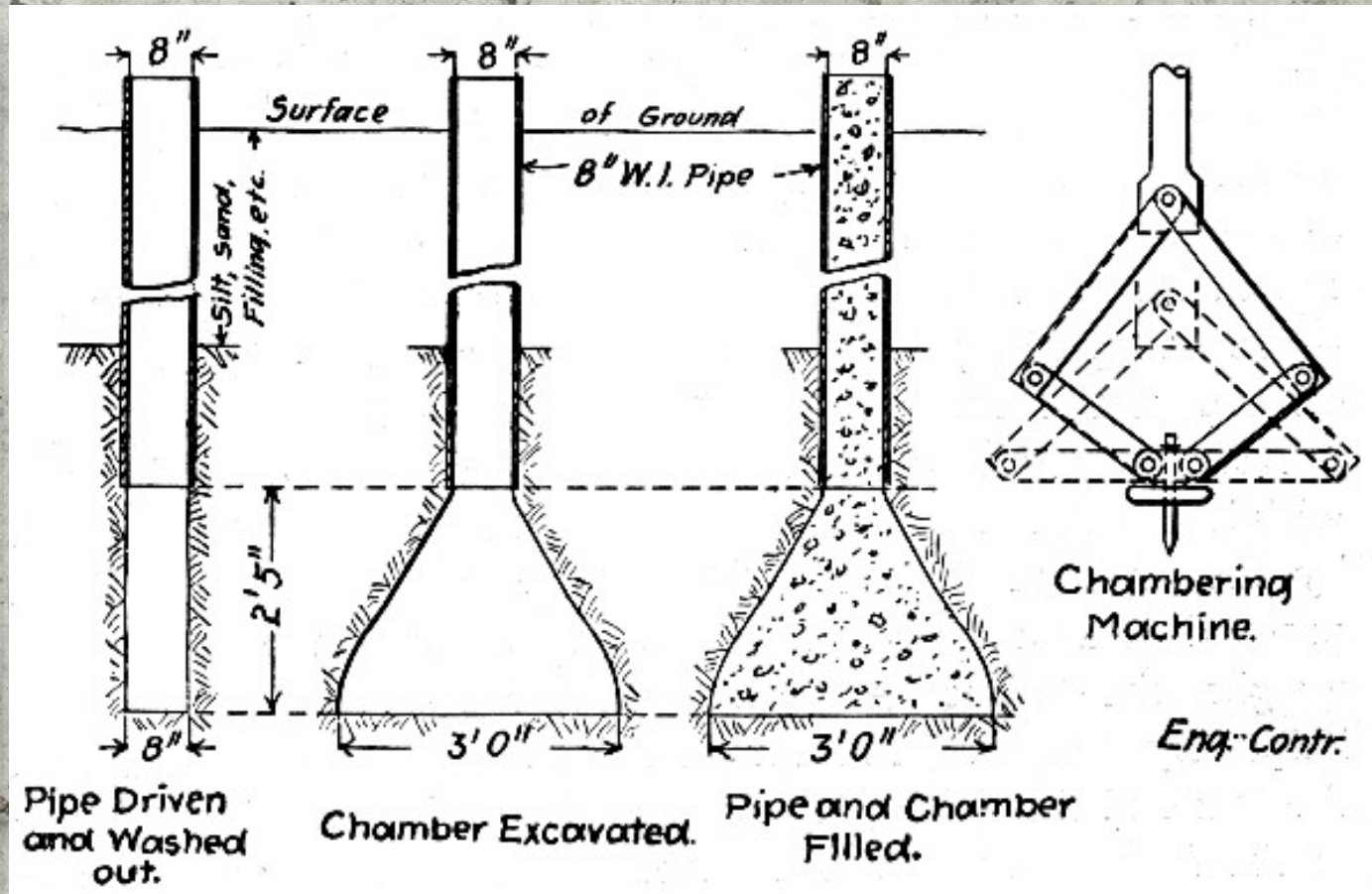

Year: 1898

Place: France

Inventor: François Hennebique

First

CONCRETE HIGH RISE BUILDING

Oldest



Ingalls Building

Year: 1903

Place: Cincinnati, USA

Architects: Elzner & Anderson

First

READY MIXED CONCRETE PATENT

Oldest



Year: 1903

Place: Hamburg, Germany

Inventor: Jürgen Hinrich Magens

First

CONCRETE ACOUSTIC MIRROR

Oldest



Year: 1916



Place: UK

First

CONCRETE TRUCKMIXER

Oldest

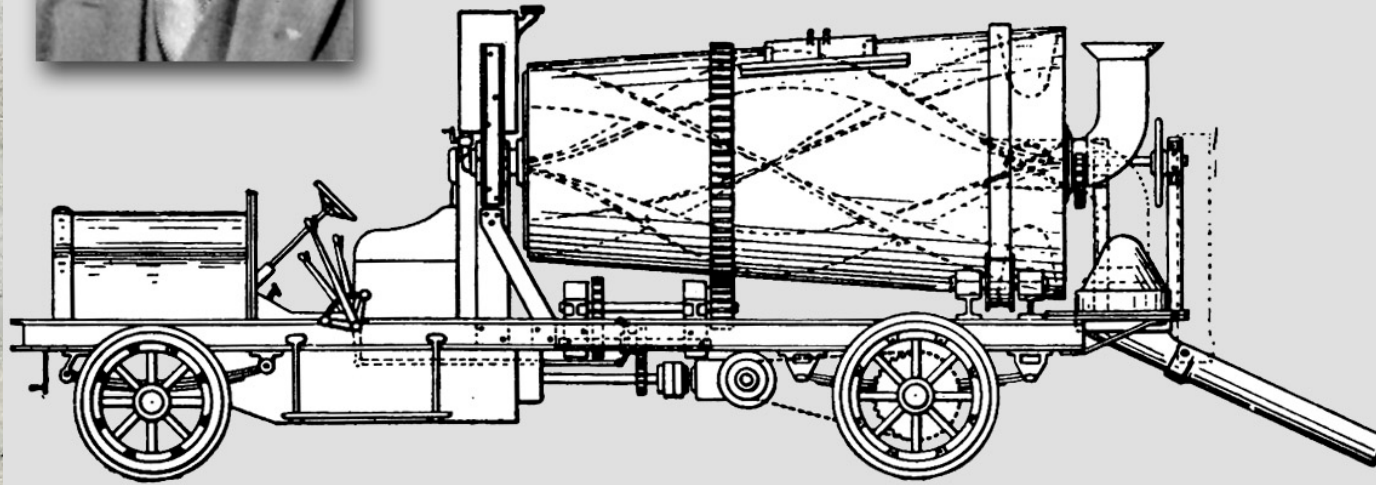

Year: 1916

Place: USA

Inventor: Stephan Stepanian

First

CONCRETE SHIP

Oldest

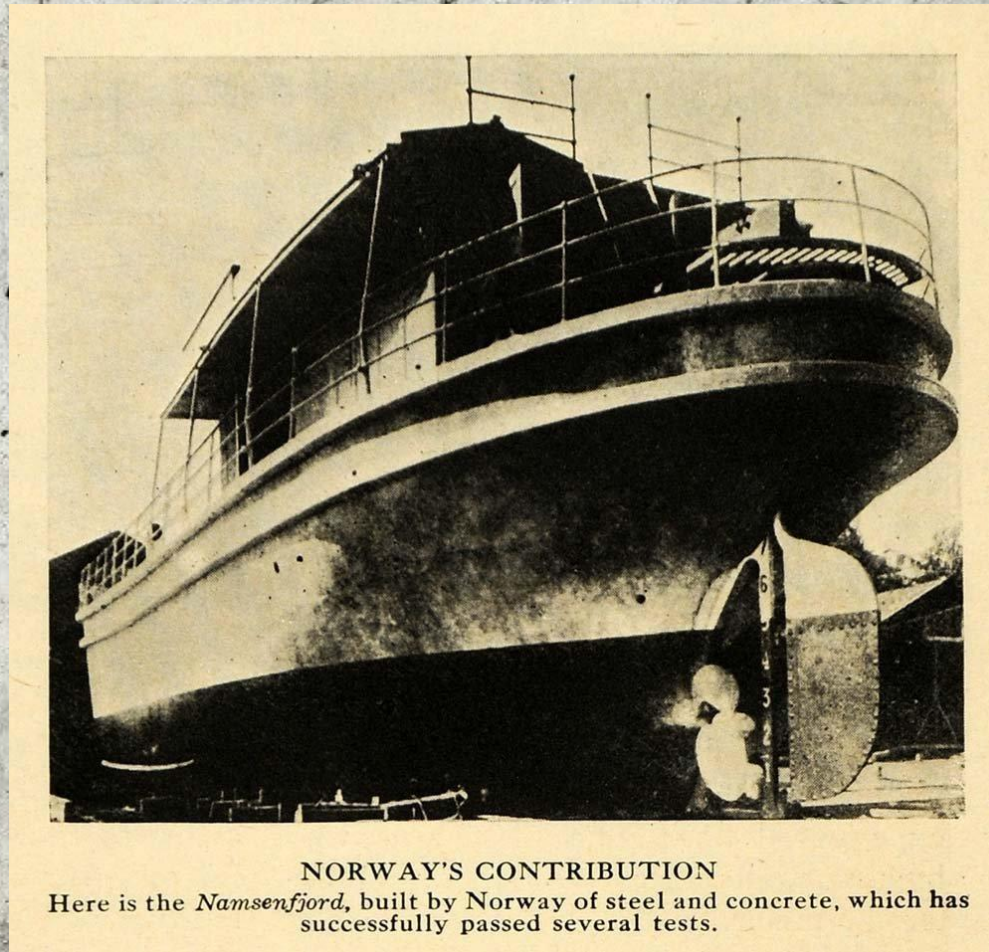

Year: 1917

Place: Norway

First

CONCRETE THIN SHELL

Oldest



Year: 1925

Place: Germany

Designer: Walther Bauersfeld

First

CONCRETE PUMPING

Oldest



Year: 1928

Place: Germany

Inventor: Max Giese & Fritz Hell

First

REINFORCED CONCRETE ARCH DAM

Oldest



Year: 1935

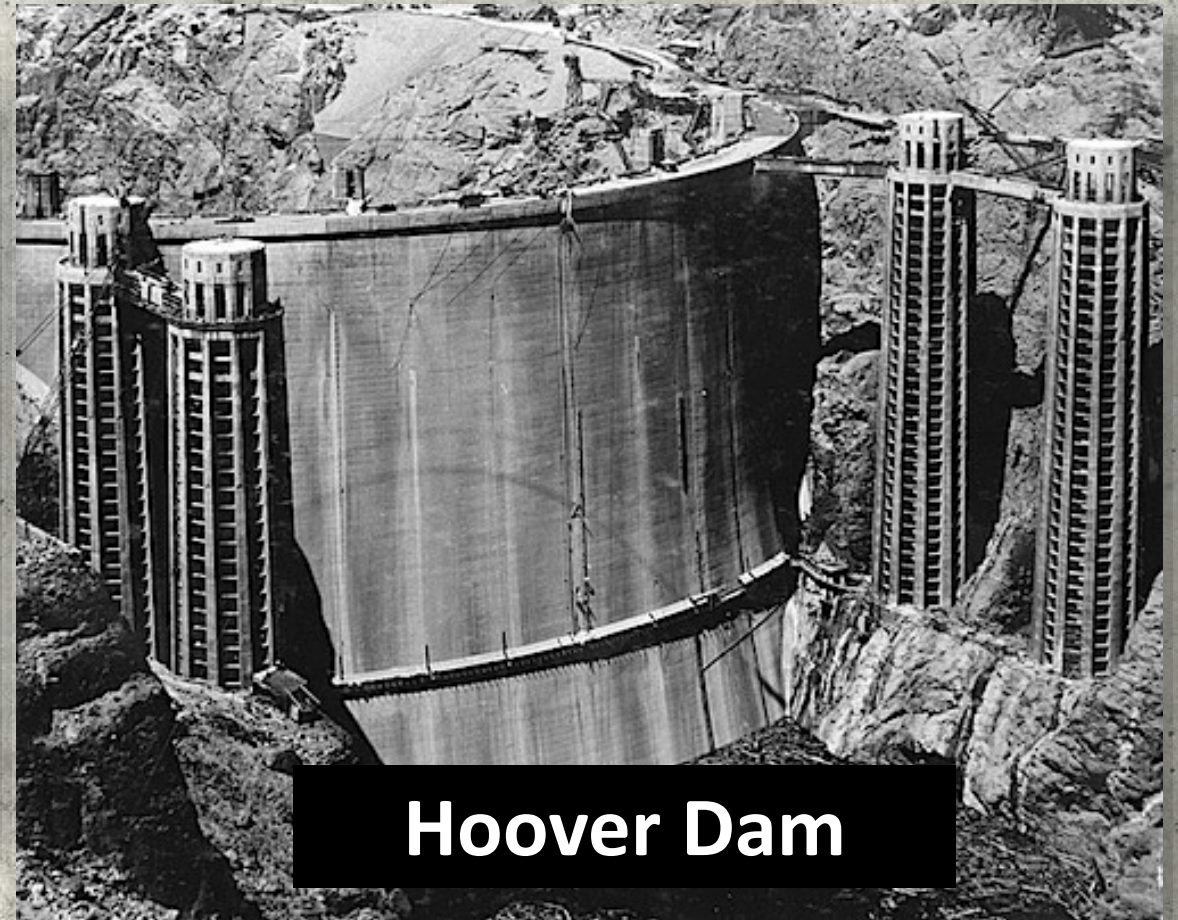

Hoover Dam

Place: USA

First

PRESTRESSED CONCRETE BRIDGE

Oldest

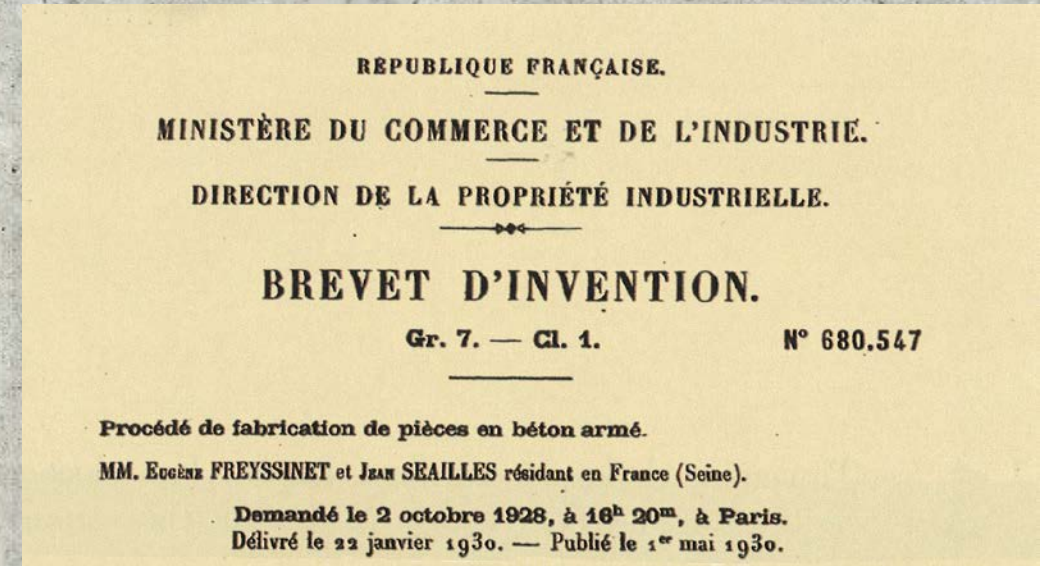

Year: 1938

Place: Oelde, Germany

Architecture: Eugene Freyssinet

First

CONCRETE PUMPING(BOOM)

Oldest

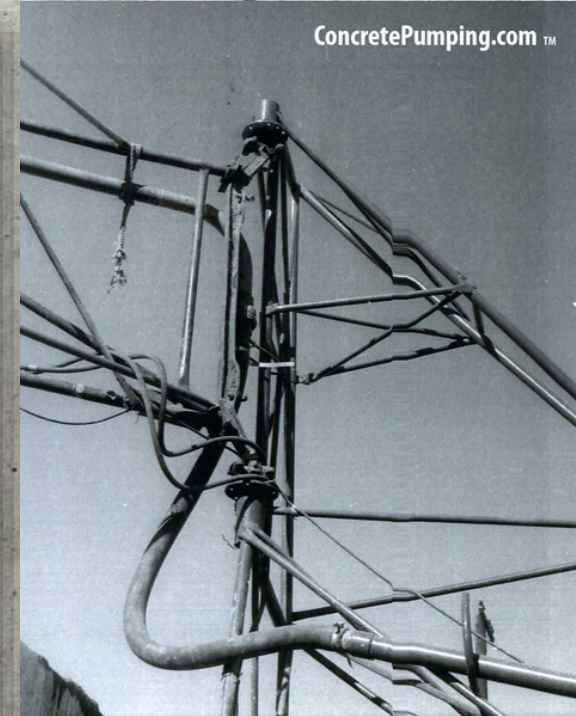
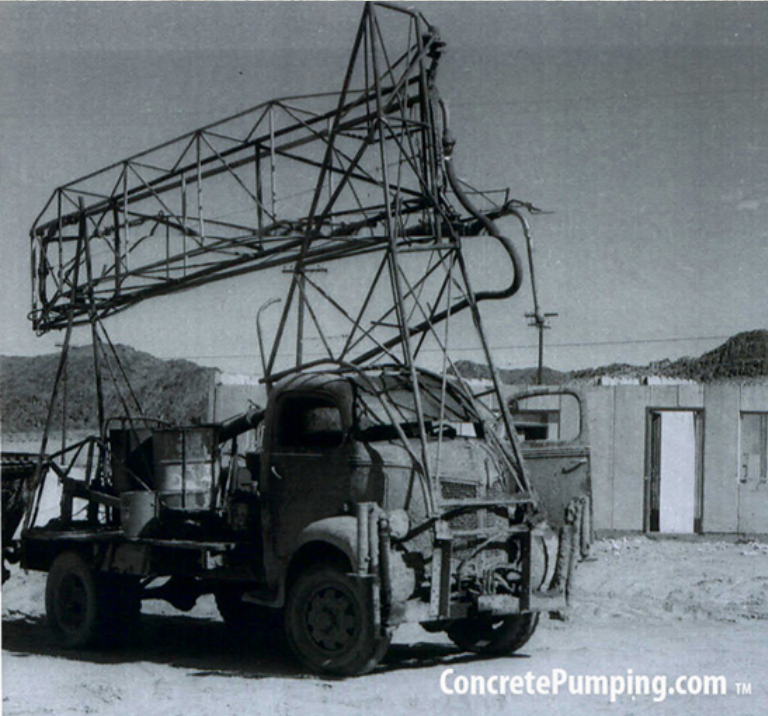

Year: 1955

Place: USA

Inventor: Richard&Marvin Bennett

First

CONCRETE TUBE STRUCTURE

Oldest



DeWitt-Chestnut Apartment



Year: 1963

Place: Chicago, USA

Designer: Fazlur Rahman Khan